



611 Argyle St. N. Caledonia, Ontario N3W 1M1

TEL: (800) 655-3447

FAX: (800) 955-4991

Email: sales@acsvalves.com

Website: www.acsvalves.com

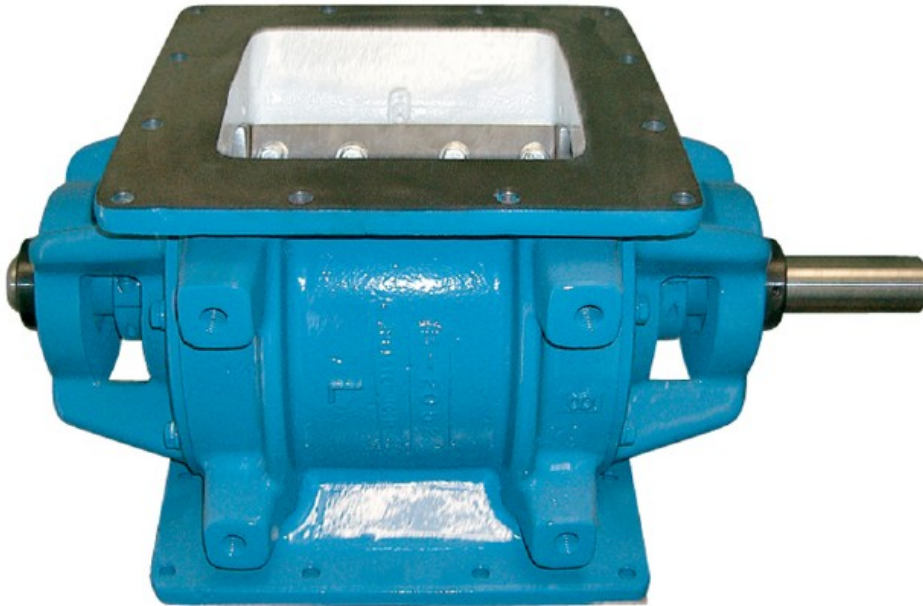

CI Series Rotary Airlock Valve

Drop-Thru Feeder/ Airlock

Features

- Available in 10 sizes
- Dependable effective design
- Heavy duty rugged construction
- Precision machining of components
- Unique shaft seal design
- Pressure differentials up to 15 psig
- Square flanges
- High temperature options up to 750° F
- Available in cast iron, 304 SS and 316 SS
- Standard 8-vane rotor design comes complete with beveled tips and sides, option 6-vane available

Options

- ACST-4 shaft seal or ACS Packing gland shaft seals available
- Housing vent ports
- Surge hoppers, blow through adapters, shear plate deflectors
- Rotor options: closed end, metering style, shallow pocket, adjustable tips, teflon coated
- Adjustable rotor tips available in EPDM, hardened steel, stainless steel, bronze, polyurethane
- Interior coating options: hard chrome, tungsten, and teflon
- Shaft seal and rotor pocket air purge
- Special drive packages
- Motion speed switch assemblies

Proprietary Information
 This drawing is the confidential property of Ancaster Conveying Systems Ltd. The reproduction, use or disclosure of this drawing without the written consent of Ancaster Conveying Systems Inc. is prohibited.

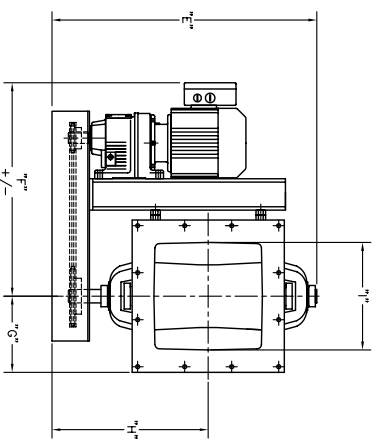

PLAN VIEW

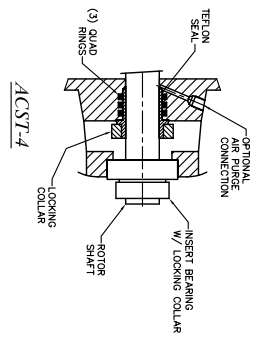

SHAFT SEAL ASSEMBLY OPTIONS

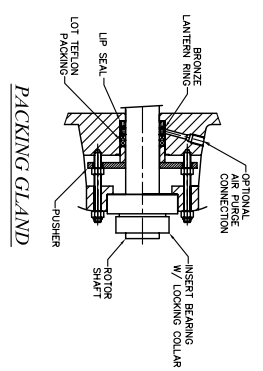

PACKING GLAND

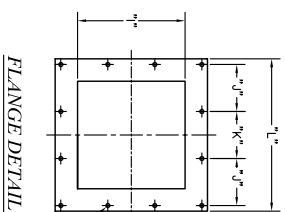

FLANGE DETAIL

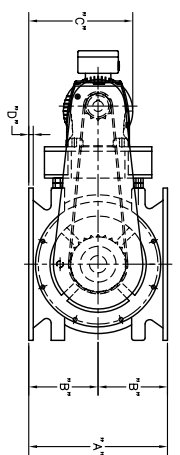

ELEVATION

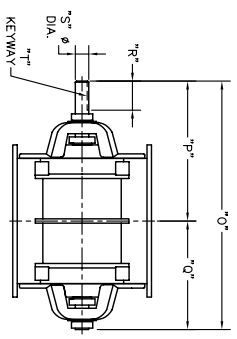

ELEVATION

ITEM	A	B	C	D	E	F	G	H	I	J	K	L	M	N	O	P	Q	R	S	T (KEYWAY)	C.F.R.	WEIGHTS
6 X 6	10	5	8 3/16	1/2	22 9/16	16 3/16	5 1/2	13 11/16	6	4 3/4	N/A	11	8	7/16	21	12 1/8	8 7/8	3 1/4	1 1/20	3/8 X 3/16	.10	225 lbs.
8 X 8	10 1/2	5 1/4	8 5/16	1/2	24 13/16	17	6	15 1/16	8	4 1/2	4	12	12	7/16	23	13 1/4	9 3/4	3 1/4	1 1/20	3/8 X 3/16	.20	240 lbs.
10 X 10	12 3/4	6 3/8	9 5/16	1/2	26 5/16	20 15/16	7 5/8	15 9/16	10	4 1/2	4 1/2	15 1/4	12	25	14 1/4	10 3/4	3 1/4	1 1/20	3/8 X 3/16	.40	400 lbs.	
12 X 12	15 1/2	7 3/4	11 5/8	1/2	29 9/16	23 13/16	8 1/2	17 7/16	12	5 1/4	5 1/4	17	12	27 3/4	15 5/8	12 7/8	3 1/4	1 1/20	3/8 X 3/16	.75	650 lbs.	
14 X 14	19	9 1/2	13 3/8	1/2	31 1/4	24	9	17 3/4	14	5 1/2	5 1/2	18	12	30 1/4	16 3/4	13 1/2	3 1/4	1 1/5160	1/2 X 1/4	1.10	700 lbs.	
16 X 16	19 1/2	9 3/4	13 3/4	1/2	34 7/16	26 3/16	10	18 15/16	15	6 1/8	6 1/4	20	12	33	17 1/2	15 1/2	3 1/4	1 1/5160	1/2 X 1/4	1.40	900 lbs.	
18 X 18	26	13	17 5/8	3/4	41 1/4	23 3/4	12	18	18	5 3/8	5 3/8	23	16	38 3/4	21 1/4	17 1/2	3 1/4	2 7/160	5/8 X 5/16	2.70	1500 lbs.	
22 X 22	30	15	20 7/8	3/4	45 5/8	29 3/4	14 3/16	26 1/8	22	6 1/2	6 1/2	28	16	42 3/4	23 1/4	19 1/2	3 1/4	2 7/160	5/8 X 5/16	4.60	2500 lbs.	
24 X 24	32 1/2	16 1/4	22 1/8	3/4	47 1/8	29 3/4	16	26 5/8	24	6	6	32	20	44 3/4	24 1/4	20 1/2	3 1/4	2 7/160	5/8 X 5/16	6.40	2700 lbs.	
26 X 26	36	18	23 11/16	3/4	52 15/16	32 7/8	17	29 7/16	26	6	6	32	20	52	28 1/2	23 1/2	3 1/4	2 7/160	5/8 X 5/16	9.00	2950 lbs.	
30 X 30	44	22	28 7/8	3/4	58 9/16	41 3/8	21 3/4	32 13/16	30	6 1/4	6 1/4	40	24	57 1/4	31 1/2	25 3/4	3 1/4	2 1/5160	3/4 X 3/8	16.50	3390 lbs.	

ISSUE	DATE	REVISION	BY

ANCASTER CONVEYING SYSTEMS LTD.
 611 ARGYLE ST. N. CALEDONIA, ONTARIO N3W-1M1
 TEL: (905) 765-2004 FAX: (905) 765-4491

TITLE: ACS MODEL C.I. SERIES ROTARY VALVES, ALL SIZES, GENERAL ARRANGEMENT
 FOR GENERAL USE ONLY

P.O. N/A
 SCALE: N.T.S.
 DATE: SEPT/23/08
 DRAWN BY: G.T.
 CHECKED:

B-2240